



Create an inviting atmosphere for retail and hospitality with new perfect-fit

MASTER LEDspot LV AR111

With its new perfect-fit design, the Master LEDspot LV AR111 now works with most of G53 luminaires as a true retrofit solution. The lamp creates a brilliant visual effect for retail and hospitality applications such as shops, showrooms and galleries. The high quality light brings out the true colors in merchandise and emphasizes its beauty. It also lasts long, with a strong lumen and color maintenance. The beautifully designed lamp offers a well-defined beam with a multitude of beam angles to suit various applications. Not only does it employ the Philips patented solution to ensure it is compatible with a broad selection of standard 12V halogen electronic transformers, it also delivers high beam intensity which equivalent to halogen AR111 spots of 50W, 75W or 100W.

Benefits

- High intensity of beam for accent lighting with strong lumen maintenance
- Achieve more vivid, vibrant colors over time for merchandise display to emphasize its beauty
- Innovative design with hassle free retrofit solution to enhance retail, hospitality environment

MASTER LEDspot LV AR111

Features

- Superior design with Red Dot award of "innovative product design"
- High intensity of beam equivalent to halogen AR111 50W, 75W, 100W
- Better color realization with high CRI value, while colors remain vibrant and natural
- High lumen and color maintenance with long lifetime of 25,000 hours to 40,000 hours
- Retrofitable with G53 luminaires

Application

- Retail: fashion, cosmetics, jewelry, food, concept stores, museums, exhibitions
- Hospitality: hotel guest room, corridors, lobby, reception area, restaurants, bars, cafes
- Home: dining room, living room, hall way

Versions



G53 AR111



G53 AR111



G53,AR111

MASTER LEDspot LV AR111

Dimensional drawing

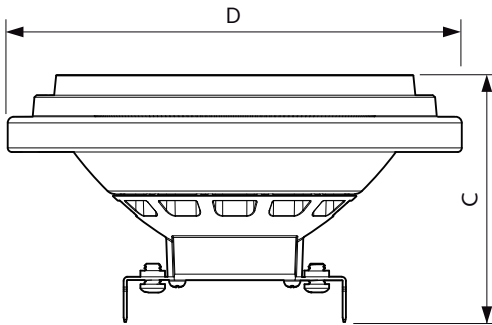

Product	D	C
MAS LEDspotLV D 11-50W 930 AR111 40D	111 mm	62 mm
MAS LEDspotLV D 11-50W 930 AR111 40D	111 mm	62 mm
MAS LEDspotLV D 15-75W 930 AR111 24D	111 mm	62 mm
MAS LEDspotLV D 15-75W 930 AR111 24D	111 mm	62 mm
MAS LEDspotLV D 20-100W 840 AR111 40D	111 mm	62 mm
MAS LEDspotLV D 11-50W 930 AR111 24D	111 mm	62 mm
MAS LEDspotLV D 11-50W 930 AR111 24D	111 mm	62 mm
MAS LEDspotLV D 20-100W 827 AR111 24D	111 mm	62 mm
MAS LEDspotLV D 15-75W 927 AR111 40D	111 mm	62 mm
MAS LEDspotLV D 15-75W 927 AR111 40D	111 mm	62 mm
MAS LEDspotLV D 15-75W 927 AR111 24D	111 mm	62 mm
MAS LEDspotLV D 15-75W 927 AR111 24D	111 mm	62 mm
MAS LEDspotLV D 20-100W 840 AR111 12D	111 mm	62.3 mm
MAS LEDspotLV D 11-50W 927 AR111 24D	111 mm	62 mm
MAS LEDspotLV D 11-50W 927 AR111 24D	111 mm	62 mm
MAS LEDspotLV D 20-100W 830 AR111 40D	111 mm	62 mm
MAS LEDspotLV D 15-75W 930 AR111 40D	111 mm	62 mm
MAS LEDspotLV D 15-75W 930 AR111 40D	111 mm	62 mm
MAS LEDspotLV D 11-50W 927 AR111 40D	111 mm	62 mm
MAS LEDspotLV D 11-50W 927 AR111 40D	111 mm	62 mm
MAS LEDspotLV D 20-100W 830 AR111 12D	111 mm	62.3 mm
MAS LEDspotLV D 20-100W 830 AR111 24D	111 mm	62 mm
MAS LEDspotLV D 20-100W 840 AR111 24D	111 mm	62 mm
MAS LEDspotLV D 11-50W 930 AR111 8D	111 mm	62 mm
MAS LEDspotLV D 11-50W 927 AR111 8D	111 mm	62 mm
MAS LEDspotLV D 20-100W 830 AR111 24D	111 mm	62 mm
MAS LEDspotLV D 20-100W 827 AR111 40D	111 mm	62 mm
MAS LEDspotLV D 20-100W 840 AR111 40D	111 mm	62 mm
MAS LEDspotLV D 20-100W 830 AR111 40D	111 mm	62 mm
MAS LEDspotLV D 20-100W 840 AR111 24D	111 mm	62 mm
MAS LEDspotLV D 15-75W 940 AR111 24D	111 mm	62 mm
MAS LEDspotLV D 15-75W 940 AR111 40D	111 mm	62 mm
MAS LEDspotLV D 20-100W 827 AR111 24D	111 mm	62 mm
MAS LEDspotLV D 11-50W 927 AR111 8D	111 mm	62 mm
MAS LEDspotLV D 11-50W 930 AR111 8D	111 mm	62 mm
MAS LEDspotLV D 20-100W 827 AR111 40D	111 mm	62 mm
MAS LEDspotLV D 15-75W 927 AR111 24D	111 mm	62 mm
MAS LEDspotLV D 15-75W 927 AR111 40D	111 mm	62 mm

MASTER LEDspot LV AR111

Controls and Dimming	
Dimmable	Yes
Operating and Electrical	
Voltage (Nom)	12 V
General Information	
Cap-Base	G53
Switching Cycle	50000X
Light Technical	
Llmf At End Of Nominal Lifetime (Nom)	70 %
Mechanical and Housing	
Bulb Shape	AR111

Approval and Application

Order Code	Full Product Name	Energy Consumption kWh/ 1000 h	Energy Efficiency Label (EEL)
929001169802	MAS LEDspotLV D 11-50W 927 AR111 24D	13 kWh	A
929001169808	MAS LEDspotLV D 11-50W 927 AR111 24D	13 kWh	A
929001169902	MAS LEDspotLV D 11-50W 930 AR111 24D	13 kWh	A
929001169908	MAS LEDspotLV D 11-50W 930 AR111 24D	13 kWh	A
929001170002	MAS LEDspotLV D 11-50W 927 AR111 40D	13 kWh	A
929001170008	MAS LEDspotLV D 11-50W 927 AR111 40D	13 kWh	A
929001170102	MAS LEDspotLV D 11-50W 930 AR111 40D	13 kWh	A
929001170108	MAS LEDspotLV D 11-50W 930 AR111 40D	13 kWh	A
929001170202	MAS LEDspotLV D 15-75W 927 AR111 24D	17 kWh	A
929001170208	MAS LEDspotLV D 15-75W 927 AR111 24D	16 kWh	A
929001170268	MAS LEDspotLV D 15-75W 927 AR111 24D	17 kWh	A
929001170302	MAS LEDspotLV D 15-75W 930 AR111 24D	17 kWh	A
929001170308	MAS LEDspotLV D 15-75W 930 AR111 24D	17 kWh	A
929001170402	MAS LEDspotLV D 15-75W 927 AR111 40D	17 kWh	A
929001170408	MAS LEDspotLV D 15-75W 927 AR111 40D	17 kWh	A

Order Code	Full Product Name	Energy Consumption kWh/ 1000 h	Energy Efficiency Label (EEL)
929001170468	MAS LEDspotLV D 15-75W 927 AR111 40D	17 kWh	A
929001170502	MAS LEDspotLV D 15-75W 930 AR111 40D	17 kWh	A
929001170508	MAS LEDspotLV D 15-75W 930 AR111 40D	17 kWh	A
929001170708	MAS LEDspotLV D 20-100W 840 AR111 12D	22 kWh	-
929001170802	MAS LEDspotLV D 20-100W 827 AR111 24D	22 kWh	A
929001170808	MAS LEDspotLV D 20-100W 827 AR111 24D	22 kWh	A
929001170902	MAS LEDspotLV D 20-100W 830 AR111 24D	22 kWh	A
929001170908	MAS LEDspotLV D 20-100W 830 AR111 24D	22 kWh	-
929001171002	MAS LEDspotLV D 20-100W 840 AR111 24D	22 kWh	A
929001171008	MAS LEDspotLV D 20-100W 840 AR111 24D	22 kWh	A
929001171102	MAS LEDspotLV D 20-100W 827 AR111 40D	22 kWh	A
929001171108	MAS LEDspotLV D 20-100W 827 AR111 40D	22 kWh	A
929001171202	MAS LEDspotLV D 20-100W 830 AR111 40D	22 kWh	A
929001171208	MAS LEDspotLV D 20-100W 830 AR111 40D	22 kWh	-
929001171302	MAS LEDspotLV D 20-100W 840 AR111 40D	22 kWh	A

MASTER LEDspot LV AR111

Order Code	Full Product Name	Energy Consumption kWh/1000 h	Energy Efficiency Label (EEL)
929001171308	MAS LEDspotLV D 20-100W 840 AR111 40D	22 kWh	-
929001329702	MAS LEDspotLV D 15-75W 940 AR111 24D	17 kWh	A
929001330002	MAS LEDspotLV D 15-75W 940 AR111 40D	17 kWh	A
929001170608	MAS LEDspotLV D 20-100W 830 AR111 12D	22 kWh	-

Order Code	Full Product Name	Energy Consumption kWh/1000 h	Energy Efficiency Label (EEL)
929001243902	MAS LEDspotLV D 11-50W 927 AR111 8D	13 kWh	A
929001243908	MAS LEDspotLV D 11-50W 927 AR111 8D	13 kWh	A
929001244002	MAS LEDspotLV D 11-50W 930 AR111 8D	13 kWh	A
929001244008	MAS LEDspotLV D 11-50W 930 AR111 8D	13 kWh	A

Operating and Electrical

Order Code	Full Product Name	Wattage Equivalent	Power (Rated) (Nom)	Starting Time (Nom)
929001169802	MAS LEDspotLV D 11-50W 927 AR111 24D	50 W	11 W	0.5 s
929001169808	MAS LEDspotLV D 11-50W 927 AR111 24D	50 W	11 W	0.5 s
929001169902	MAS LEDspotLV D 11-50W 930 AR111 24D	50 W	11 W	0.5 s
929001169908	MAS LEDspotLV D 11-50W 930 AR111 24D	50 W	11 W	0.5 s
929001170002	MAS LEDspotLV D 11-50W 927 AR111 40D	50 W	11 W	0.5 s
929001170008	MAS LEDspotLV D 11-50W 927 AR111 40D	50 W	11 W	0.5 s
929001170102	MAS LEDspotLV D 11-50W 930 AR111 40D	50 W	11 W	0.5 s
929001170108	MAS LEDspotLV D 11-50W 930 AR111 40D	50 W	11 W	0.5 s
929001170202	MAS LEDspotLV D 15-75W 927 AR111 24D	75 W	15 W	0.5 s
929001170208	MAS LEDspotLV D 15-75W 927 AR111 24D	75 W	15 W	0.5 s
929001170268	MAS LEDspotLV D 15-75W 927 AR111 24D	75 W	15 W	0.5 s
929001170302	MAS LEDspotLV D 15-75W 930 AR111 24D	75 W	15 W	0.5 s
929001170308	MAS LEDspotLV D 15-75W 930 AR111 24D	75 W	15 W	0.5 s
929001170402	MAS LEDspotLV D 15-75W 927 AR111 40D	75 W	15 W	0.5 s
929001170408	MAS LEDspotLV D 15-75W 927 AR111 40D	75 W	15 W	0.5 s
929001170468	MAS LEDspotLV D 15-75W 927 AR111 40D	75 W	15 W	0.5 s
929001170502	MAS LEDspotLV D 15-75W 930 AR111 40D	75 W	15 W	0.5 s
929001170508	MAS LEDspotLV D 15-75W 930 AR111 40D	75 W	15 W	0.5 s

Order Code	Full Product Name	Wattage Equivalent	Power (Rated) (Nom)	Starting Time (Nom)
929001170708	MAS LEDspotLV D 20-100W 840 AR111 12D	100 W	20 W	0.5 s
929001170802	MAS LEDspotLV D 20-100W 827 AR111 24D	100 W	20 W	0.5 s
929001170808	MAS LEDspotLV D 20-100W 827 AR111 24D	100 W	20 W	0.5 s
929001170902	MAS LEDspotLV D 20-100W 830 AR111 24D	100 W	20 W	0.5 s
929001170908	MAS LEDspotLV D 20-100W 830 AR111 24D	100 W	20 W	0.5 s
929001171002	MAS LEDspotLV D 20-100W 840 AR111 24D	100 W	20 W	0.5 s
929001171008	MAS LEDspotLV D 20-100W 840 AR111 24D	100 W	20 W	-
929001171102	MAS LEDspotLV D 20-100W 827 AR111 40D	100 W	20 W	0.5 s
929001171108	MAS LEDspotLV D 20-100W 827 AR111 40D	100 W	20 W	0.5 s
929001171202	MAS LEDspotLV D 20-100W 830 AR111 40D	100 W	20 W	0.5 s
929001171208	MAS LEDspotLV D 20-100W 830 AR111 40D	100 W	20 W	0.5 s
929001171302	MAS LEDspotLV D 20-100W 840 AR111 40D	100 W	20 W	0.5 s
929001171308	MAS LEDspotLV D 20-100W 840 AR111 40D	100 W	20 W	0.5 s
929001329702	MAS LEDspotLV D 15-75W 940 AR111 24D	75 W	15 W	0.5 s
929001330002	MAS LEDspotLV D 15-75W 940 AR111 40D	75 W	15 W	0.5 s
929001170608	MAS LEDspotLV D 20-100W 830 AR111 12D	100 W	20 W	0.5 s
929001243902	MAS LEDspotLV D 11-50W 927 AR111 8D	50 W	11 W	0.5 s
929001243908	MAS LEDspotLV D 11-50W 927 AR111 8D	50 W	11 W	0.5 s

MASTER LEDspot LV AR111

Order Code	Full Product Name	Wattage Equivalent	Power (Rated) (Nom)	Starting Time (Nom)
929001244002	MAS LEDspotLV D 11-50W 930 AR111 8D	50 W	11 W	0.5 s

Order Code	Full Product Name	Wattage Equivalent	Power (Rated) (Nom)	Starting Time (Nom)
929001244008	MAS LEDspotLV D 11-50W 930 AR111 8D	50 W	11 W	0.5 s

General Information

Order Code	Full Product Name	Nominal Lifetime (Nom)	Rated Lifetime (Hours)
929001169802	MAS LEDspotLV D 11-50W 927 AR111 24D	40000 h	40000 h
929001169808	MAS LEDspotLV D 11-50W 927 AR111 24D	40000 h	40000 h
929001169902	MAS LEDspotLV D 11-50W 930 AR111 24D	40000 h	40000 h
929001169908	MAS LEDspotLV D 11-50W 930 AR111 24D	40000 h	40000 h
929001170002	MAS LEDspotLV D 11-50W 927 AR111 40D	40000 h	40000 h
929001170008	MAS LEDspotLV D 11-50W 927 AR111 40D	40000 h	40000 h
929001170102	MAS LEDspotLV D 11-50W 930 AR111 40D	40000 h	40000 h
929001170108	MAS LEDspotLV D 11-50W 930 AR111 40D	40000 h	40000 h
929001170202	MAS LEDspotLV D 15-75W 927 AR111 24D	40000 h	40000 h
929001170208	MAS LEDspotLV D 15-75W 927 AR111 24D	40000 h	40000 h
929001170268	MAS LEDspotLV D 15-75W 927 AR111 24D	40000 h	40000 h
929001170302	MAS LEDspotLV D 15-75W 930 AR111 24D	40000 h	40000 h
929001170308	MAS LEDspotLV D 15-75W 930 AR111 24D	40000 h	40000 h
929001170402	MAS LEDspotLV D 15-75W 927 AR111 40D	40000 h	40000 h
929001170408	MAS LEDspotLV D 15-75W 927 AR111 40D	40000 h	40000 h
929001170468	MAS LEDspotLV D 15-75W 927 AR111 40D	40000 h	40000 h
929001170502	MAS LEDspotLV D 15-75W 930 AR111 40D	40000 h	40000 h
929001170508	MAS LEDspotLV D 15-75W 930 AR111 40D	40000 h	40000 h
929001170708	MAS LEDspotLV D 20-100W 840 AR111 12D	25000 h	25000 h

Order Code	Full Product Name	Nominal Lifetime (Nom)	Rated Lifetime (Hours)
929001170802	MAS LEDspotLV D 20-100W 827 AR111 24D	25000 h	25000 h
929001170808	MAS LEDspotLV D 20-100W 827 AR111 24D	25000 h	25000 h
929001170902	MAS LEDspotLV D 20-100W 830 AR111 24D	25000 h	25000 h
929001170908	MAS LEDspotLV D 20-100W 830 AR111 24D	25000 h	25000 h
929001171002	MAS LEDspotLV D 20-100W 840 AR111 24D	25000 h	25000 h
929001171008	MAS LEDspotLV D 20-100W 840 AR111 24D	25000 h	25000 h
929001171102	MAS LEDspotLV D 20-100W 827 AR111 40D	25000 h	25000 h
929001171108	MAS LEDspotLV D 20-100W 827 AR111 40D	25000 h	25000 h
929001171202	MAS LEDspotLV D 20-100W 830 AR111 40D	25000 h	25000 h
929001171208	MAS LEDspotLV D 20-100W 830 AR111 40D	25000 h	25000 h
929001171302	MAS LEDspotLV D 20-100W 840 AR111 40D	25000 h	25000 h
929001171308	MAS LEDspotLV D 20-100W 840 AR111 40D	25000 h	25000 h
929001329702	MAS LEDspotLV D 15-75W 940 AR111 24D	40000 h	40000 h
929001330002	MAS LEDspotLV D 15-75W 940 AR111 40D	40000 h	40000 h
929001170608	MAS LEDspotLV D 20-100W 830 AR111 12D	25000 h	25000 h
929001243902	MAS LEDspotLV D 11-50W 927 AR111 8D	40000 h	40000 h
929001243908	MAS LEDspotLV D 11-50W 927 AR111 8D	40000 h	40000 h
929001244002	MAS LEDspotLV D 11-50W 930 AR111 8D	40000 h	40000 h
929001244008	MAS LEDspotLV D 11-50W 930 AR111 8D	40000 h	40000 h

Light Technical (1/2)

MASTER LEDspot LV AR111

Order Code	Full Product Name	Beam Angle (Nom)	Color Code	Correlated Color Temperature (Nom)	Color		Luminous Flux (Nom)	Luminous Flux (Rated) (Nom)
					Rendering Index (Nom)	Light Distribution		
929001169802	MAS LEDspotLV D 11-50W 927 AR111 24D	24 °	927	2700 K	90	Medium beam 24°	560 lm	560 lm
929001169808	MAS LEDspotLV D 11-50W 927 AR111 24D	24 °	927	2700 K	90	Medium beam 24°	620 lm	620 lm
929001169902	MAS LEDspotLV D 11-50W 930 AR111 24D	24 °	930	3000 K	90	Medium beam 24°	580 lm	580 lm
929001169908	MAS LEDspotLV D 11-50W 930 AR111 24D	24 °	930	3000 K	90	Medium beam 24°	640 lm	640 lm
929001170002	MAS LEDspotLV D 11-50W 927 AR111 40D	40 °	927	2700 K	90	Wide beam 40°	550 lm	550 lm
929001170008	MAS LEDspotLV D 11-50W 927 AR111 40D	40 °	927	2700 K	90	Wide beam 40°	620 lm	620 lm
929001170102	MAS LEDspotLV D 11-50W 930 AR111 40D	40 °	930	3000 K	90	Wide beam 40°	570 lm	570 lm
929001170108	MAS LEDspotLV D 11-50W 930 AR111 40D	40 °	930	3000 K	90	Wide beam 40°	640 lm	640 lm
929001170202	MAS LEDspotLV D 15-75W 927 AR111 24D	24 °	927	2700 K	90	Medium beam 24°	800 lm	800 lm
929001170208	MAS LEDspotLV D 15-75W 927 AR111 24D	24 °	927	2700 K	90	Medium beam 24°	830 lm	830 lm
929001170268	MAS LEDspotLV D 15-75W 927 AR111 24D	24 °	927	2700 K	90	Medium beam 24°	830 lm	830 lm
929001170302	MAS LEDspotLV D 15-75W 930 AR111 24D	24 °	930	3000 K	90	Medium beam 24°	810 lm	810 lm
929001170308	MAS LEDspotLV D 15-75W 930 AR111 24D	24 °	930	3000 K	90	Medium beam 24°	840 lm	840 lm
929001170402	MAS LEDspotLV D 15-75W 927 AR111 40D	40 °	927	2700 K	90	Wide beam 40°	800 lm	800 lm
929001170408	MAS LEDspotLV D 15-75W 927 AR111 40D	40 °	927	2700 K	90	Wide beam 40°	830 lm	830 lm
929001170468	MAS LEDspotLV D 15-75W 927 AR111 40D	40 °	927	2700 K	90	Wide beam 40°	830 lm	830 lm
929001170502	MAS LEDspotLV D 15-75W 930 AR111 40D	40 °	930	3000 K	90	Wide beam 40°	810 lm	810 lm
929001170508	MAS LEDspotLV D 15-75W 930 AR111 40D	40 °	930	3000 K	90	Wide beam 40°	840 lm	840 lm
929001170708	MAS LEDspotLV D 20-100W 840 AR111 12D	12 °	840	4000 K	80	Narrow beam 12°	1400 lm	1400 lm
929001170802	MAS LEDspotLV D 20-100W 827 AR111 24D	24 °	827	2700 K	80	Medium beam 24°	1180 lm	1180 lm
929001170808	MAS LEDspotLV D 20-100W 827 AR111 24D	24 °	827	2700 K	80	Medium beam 24°	1300 lm	1300 lm
929001170902	MAS LEDspotLV D 20-100W 830 AR111 24D	24 °	830	3000 K	80	Medium beam 25°	1200 lm	1200 lm
929001170908	MAS LEDspotLV D 20-100W 830 AR111 24D	25 °	830	3000 K	80	Medium beam 25°	1280 lm	1280 lm
929001171002	MAS LEDspotLV D 20-100W 840 AR111 24D	24 °	840	4000 K	80	-	1250 lm	1250 lm
929001171008	MAS LEDspotLV D 20-100W 840 AR111 24D	24 °	840	4000 K	80	-	1400 lm	1400 lm

MASTER LEDspot LV AR111

Order Code	Full Product Name	Beam Angle (Nom)	Color Code	Correlated Color Temperature (Nom)	Color		Luminous Flux (Nom)	Luminous Flux (Rated) (Nom)
					Rendering Index (Nom)	Light Distribution		
929001171102	MAS LEDspotLV D 20-100W 827 AR111 40D	40 °	827	2700 K	80	-	1160 lm	1160 lm
929001171108	MAS LEDspotLV D 20-100W 827 AR111 40D	40 °	827	2700 K	80	-	1300 lm	1300 lm
929001171202	MAS LEDspotLV D 20-100W 830 AR111 40D	40 °	830	3000 K	80	Wide beam 40°	1180 lm	1180 lm
929001171208	MAS LEDspotLV D 20-100W 830 AR111 40D	40 °	830	3000 K	80	Wide beam 40°	1350 lm	1350 lm
929001171302	MAS LEDspotLV D 20-100W 840 AR111 40D	40 °	840	4000 K	80	Wide beam 40°	1250 lm	1250 lm
929001171308	MAS LEDspotLV D 20-100W 840 AR111 40D	40 °	840	4000 K	80	Wide beam 40°	1400 lm	1400 lm
929001329702	MAS LEDspotLV D 15-75W 940 AR111 24D	24 °	940	4000 K	90	-	830 lm	830 lm
929001330002	MAS LEDspotLV D 15-75W 940 AR111 40D	40 °	940	4000 K	90	-	830 lm	830 lm
929001170608	MAS LEDspotLV D 20-100W 830 AR111 12D	12 °	830	3000 K	80	Narrow beam 12°	1350 lm	1350 lm
929001243902	MAS LEDspotLV D 11-50W 927 AR111 8D	8 °	927	2700 K	90	-	560 lm	560 lm
929001243908	MAS LEDspotLV D 11-50W 927 AR111 8D	8 °	927	2700 K	90	-	600 lm	600 lm
929001244002	MAS LEDspotLV D 11-50W 930 AR111 8D	8 °	930	3000 K	90	-	580 lm	580 lm
929001244008	MAS LEDspotLV D 11-50W 930 AR111 8D	8 °	930	3000 K	90	-	610 lm	610 lm

Light Technical (2/2)

Order Code	Full Product Name	Luminous Intensity (Nom)	Rated Beam Angle	Order Code	Full Product Name	Luminous Intensity (Nom)	Rated Beam Angle
929001169802	MAS LEDspotLV D 11-50W 927 AR111 24D	2900 cd	24 °	929001170208	MAS LEDspotLV D 15-75W 927 AR111 24D	3900 cd	24 °
929001169808	MAS LEDspotLV D 11-50W 927 AR111 24D	2900 cd	24 °	929001170268	MAS LEDspotLV D 15-75W 927 AR111 24D	3900 cd	24 °
929001169902	MAS LEDspotLV D 11-50W 930 AR111 24D	3000 cd	24 °	929001170302	MAS LEDspotLV D 15-75W 930 AR111 24D	4000 cd	24 °
929001169908	MAS LEDspotLV D 11-50W 930 AR111 24D	3000 cd	24 °	929001170308	MAS LEDspotLV D 15-75W 930 AR111 24D	4000 cd	24 °
929001170002	MAS LEDspotLV D 11-50W 927 AR111 40D	1100 cd	40 °	929001170402	MAS LEDspotLV D 15-75W 927 AR111 40D	1400 cd	40 °
929001170008	MAS LEDspotLV D 11-50W 927 AR111 40D	1100 cd	40 °	929001170408	MAS LEDspotLV D 15-75W 927 AR111 40D	1400 cd	40 °
929001170102	MAS LEDspotLV D 11-50W 930 AR111 40D	1150 cd	40 °	929001170468	MAS LEDspotLV D 15-75W 927 AR111 40D	1400 cd	40 °
929001170108	MAS LEDspotLV D 11-50W 930 AR111 40D	1150 cd	40 °	929001170502	MAS LEDspotLV D 15-75W 930 AR111 40D	1450 cd	40 °
929001170202	MAS LEDspotLV D 15-75W 927 AR111 24D	3900 cd	24 °	929001170508	MAS LEDspotLV D 15-75W 930 AR111 40D	1450 cd	40 °

MASTER LEDspot LV AR111

Order Code	Full Product Name	Luminous Intensity (Nom)	Rated Beam Angle
929001170708	MAS LEDspotLV D 20-100W 840 AR111 12D	11000 cd	12 °
929001170802	MAS LEDspotLV D 20-100W 827 AR111 24D	5800 cd	24 °
929001170808	MAS LEDspotLV D 20-100W 827 AR111 24D	5800 cd	24 °
929001170902	MAS LEDspotLV D 20-100W 830 AR111 24D	6000 cd	24 °
929001170908	MAS LEDspotLV D 20-100W 830 AR111 24D	5800 cd	25 °
929001171002	MAS LEDspotLV D 20-100W 840 AR111 24D	6100 cd	24 °
929001171008	MAS LEDspotLV D 20-100W 840 AR111 24D	6100 cd	24 °
929001171102	MAS LEDspotLV D 20-100W 827 AR111 40D	2300 cd	40 °
929001171108	MAS LEDspotLV D 20-100W 827 AR111 40D	2300 cd	40 °
929001171202	MAS LEDspotLV D 20-100W 830 AR111 40D	2350 cd	40 °

Order Code	Full Product Name	Luminous Intensity (Nom)	Rated Beam Angle
929001171208	MAS LEDspotLV D 20-100W 830 AR111 40D	2350 cd	40 °
929001171302	MAS LEDspotLV D 20-100W 840 AR111 40D	2400 cd	40 °
929001171308	MAS LEDspotLV D 20-100W 840 AR111 40D	2350 cd	40 °
929001329702	MAS LEDspotLV D 15-75W 940 AR111 24D	4100 cd	24 °
929001330002	MAS LEDspotLV D 15-75W 940 AR111 40D	1500 cd	40 °
929001170608	MAS LEDspotLV D 20-100W 830 AR111 12D	10000 cd	12 °
929001243902	MAS LEDspotLV D 11-50W 927 AR111 8D	7800 cd	8 °
929001243908	MAS LEDspotLV D 11-50W 927 AR111 8D	7800 cd	8 °
929001244002	MAS LEDspotLV D 11-50W 930 AR111 8D	8000 cd	8 °
929001244008	MAS LEDspotLV D 11-50W 930 AR111 8D	8000 cd	8 °

Temperature

Order Code	Full Product Name	T-Case Maximum (Nom)
929001169802	MAS LEDspotLV D 11-50W 927 AR111 24D	70 °C
929001169808	MAS LEDspotLV D 11-50W 927 AR111 24D	70 °C
929001169902	MAS LEDspotLV D 11-50W 930 AR111 24D	70 °C
929001169908	MAS LEDspotLV D 11-50W 930 AR111 24D	70 °C
929001170002	MAS LEDspotLV D 11-50W 927 AR111 40D	70 °C
929001170008	MAS LEDspotLV D 11-50W 927 AR111 40D	70 °C
929001170102	MAS LEDspotLV D 11-50W 930 AR111 40D	70 °C
929001170108	MAS LEDspotLV D 11-50W 930 AR111 40D	70 °C
929001170202	MAS LEDspotLV D 15-75W 927 AR111 24D	74 °C
929001170208	MAS LEDspotLV D 15-75W 927 AR111 24D	74 °C
929001170268	MAS LEDspotLV D 15-75W 927 AR111 24D	74 °C
929001170302	MAS LEDspotLV D 15-75W 930 AR111 24D	74 °C
929001170308	MAS LEDspotLV D 15-75W 930 AR111 24D	74 °C
929001170402	MAS LEDspotLV D 15-75W 927 AR111 40D	74 °C
929001170408	MAS LEDspotLV D 15-75W 927 AR111 40D	74 °C
929001170468	MAS LEDspotLV D 15-75W 927 AR111 40D	74 °C
929001170502	MAS LEDspotLV D 15-75W 930 AR111 40D	74 °C
929001170508	MAS LEDspotLV D 15-75W 930 AR111 40D	74 °C
929001170708	MAS LEDspotLV D 20-100W 840 AR111 12D	80 °C
929001170802	MAS LEDspotLV D 20-100W 827 AR111 24D	80 °C
929001170808	MAS LEDspotLV D 20-100W 827 AR111 24D	80 °C
929001170902	MAS LEDspotLV D 20-100W 830 AR111 24D	80 °C
929001170908	MAS LEDspotLV D 20-100W 830 AR111 24D	80 °C
929001171002	MAS LEDspotLV D 20-100W 840 AR111 24D	80 °C
929001171008	MAS LEDspotLV D 20-100W 840 AR111 24D	-
929001171102	MAS LEDspotLV D 20-100W 827 AR111 40D	80 °C
929001171108	MAS LEDspotLV D 20-100W 827 AR111 40D	80 °C

Order Code	Full Product Name	T-Case Maximum (Nom)
929001171202	MAS LEDspotLV D 20-100W 830 AR111 40D	80 °C
929001171208	MAS LEDspotLV D 20-100W 830 AR111 40D	80 °C
929001171302	MAS LEDspotLV D 20-100W 840 AR111 40D	80 °C
929001171308	MAS LEDspotLV D 20-100W 840 AR111 40D	80 °C
929001329702	MAS LEDspotLV D 15-75W 940 AR111 24D	74 °C
929001330002	MAS LEDspotLV D 15-75W 940 AR111 40D	74 °C
929001170608	MAS LEDspotLV D 20-100W 830 AR111 12D	80 °C
929001243902	MAS LEDspotLV D 11-50W 927 AR111 8D	70 °C
929001243908	MAS LEDspotLV D 11-50W 927 AR111 8D	70 °C
929001244002	MAS LEDspotLV D 11-50W 930 AR111 8D	70 °C
929001244008	MAS LEDspotLV D 11-50W 930 AR111 8D	70 °C

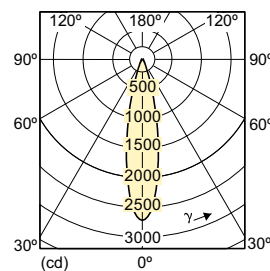

MASTER LEDspot LV AR111

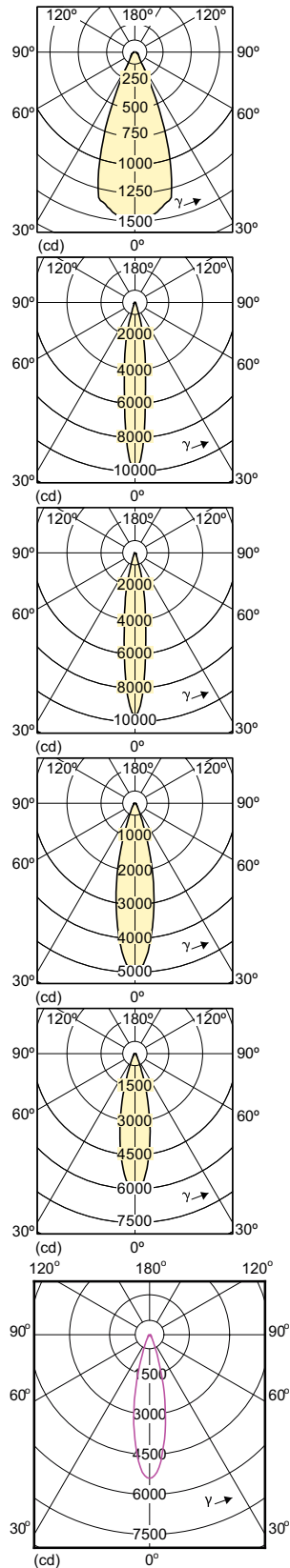
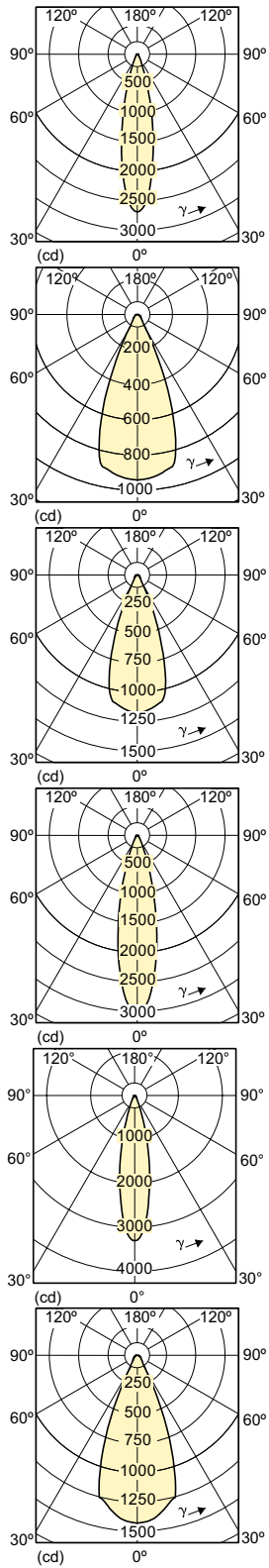

MASTER LEDspot LV AR111

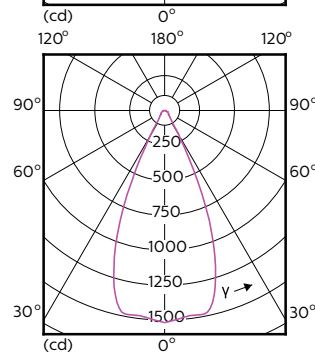
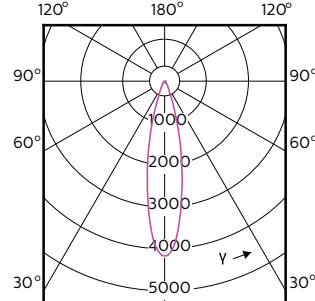
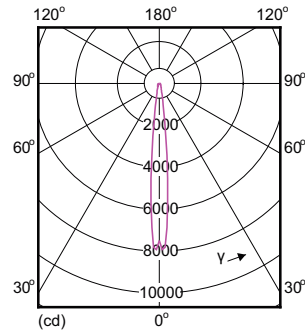
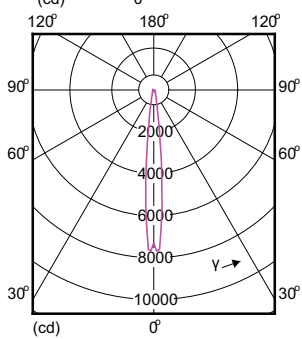
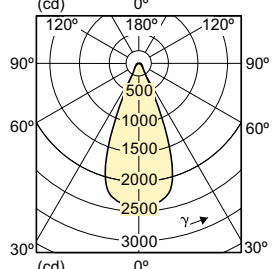
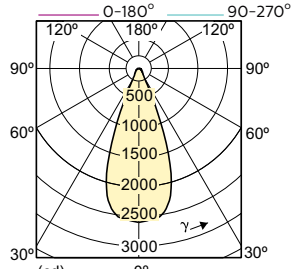
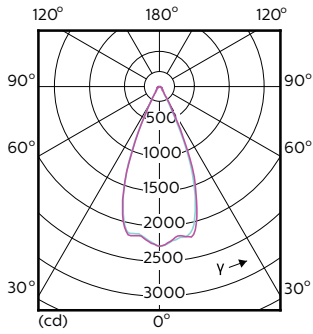

Accent Diagrams

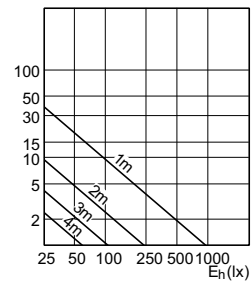
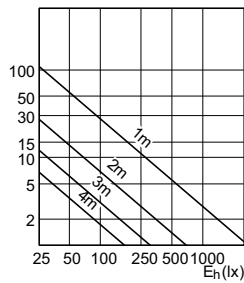
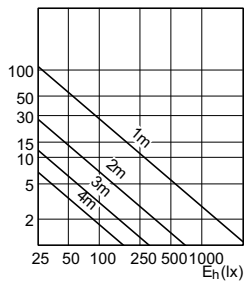

SDAC_LEDspotL_0132-Accent diagram

MASTER LEDspot LV AR111

Accent Diagrams

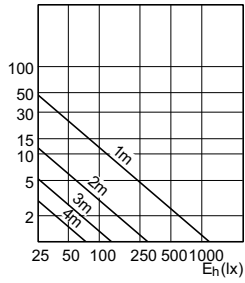

SDAC_LEDspotL_0135-Accent diagram

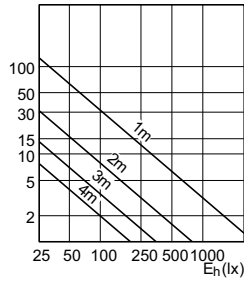

SDAC_LEDspotL_0136-Accent diagram

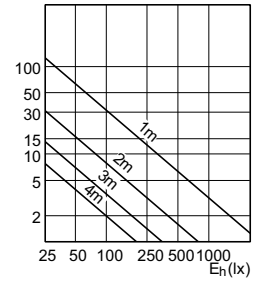

SDAC_LEDspotL_0137-Accent diagram

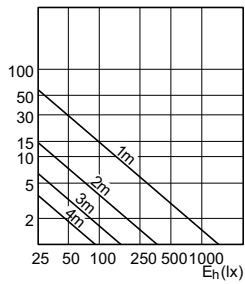

SDAC_LEDspotL_0138-Accent diagram

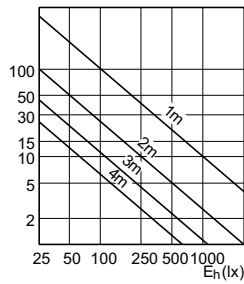

SDAC_LEDspotL_0143-Accent diagram

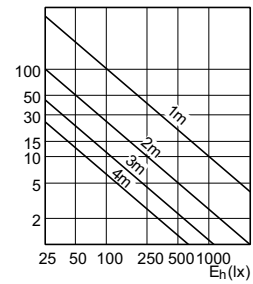

SDAC_LEDspotL_0144-Accent diagram

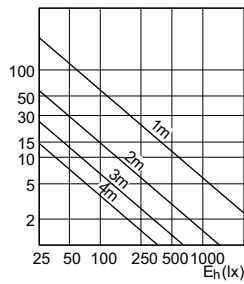
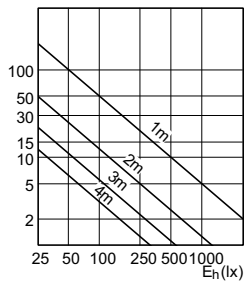

LEDspot, LEDspotLV 20-100W AR111 830 24D

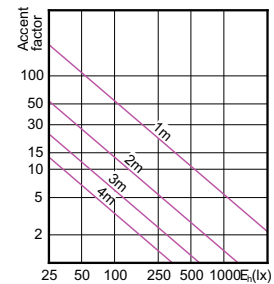

MASTER LEDspotLV 20-100W AR111 G53_4000K 1400lm 24D

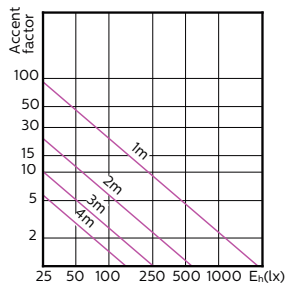

MASTER LEDspotLV AR111 100W G53 827 40D

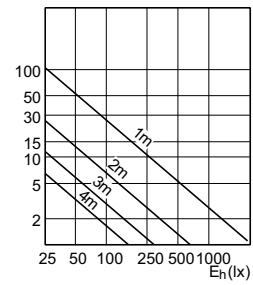
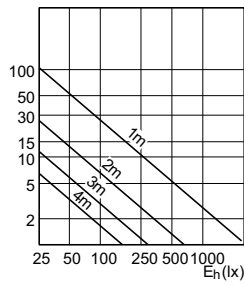

SDAC_LEDspotL_0142-Accent diagram

MASTER LEDspot LV AR111

Accent Diagrams

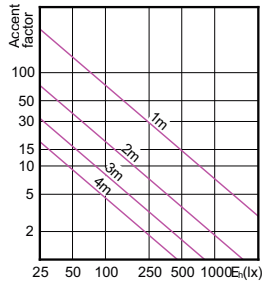

LED Lamps, MAS LEDspotLV D 11-50W AR111
G53 827 8D

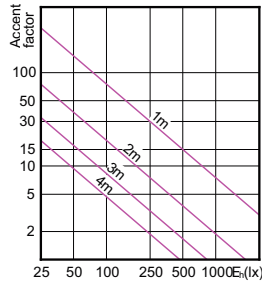

LED Lamps, MAS LEDspotLV D 11-50W AR111
G53 830 8D

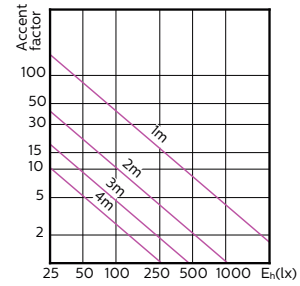

MASTER LEDspotLV AR111 75W G53 940 24D

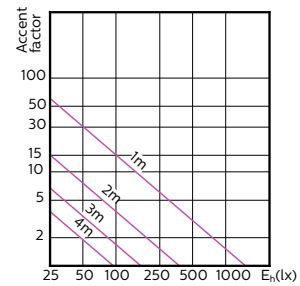

MASTER LEDspotLV AR111 75W G53 940 40D

Beam Diagrams

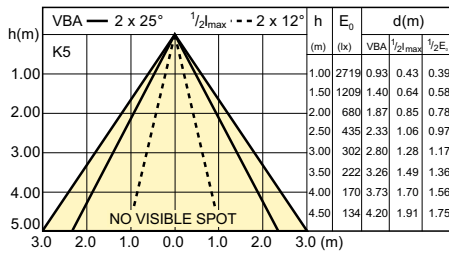

SDBE_LEDspotL_0132-Beam diagram

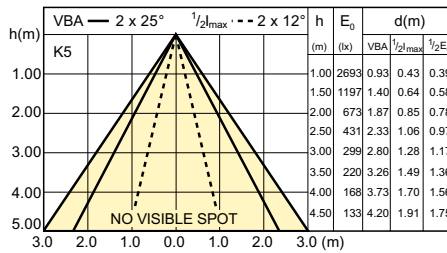

SDBE_LEDspotL_0133-Beam diagram

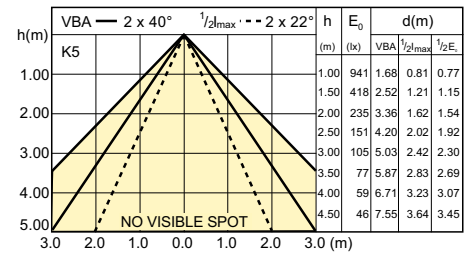

SDBE_LEDspotL_0134-Beam diagram

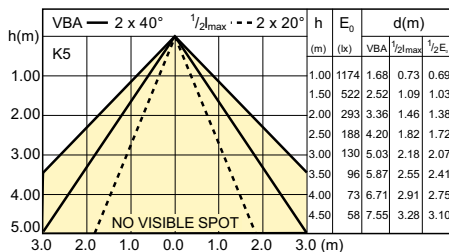

SDBE_LEDspotL_0135-Beam diagram

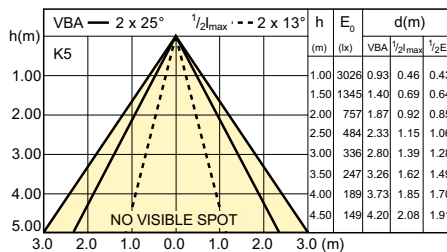

SDBE_LEDspotL_0136-Beam diagram

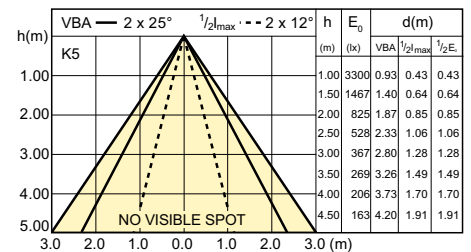

SDBE_LEDspotL_0137-Beam diagram

Beam Diagrams

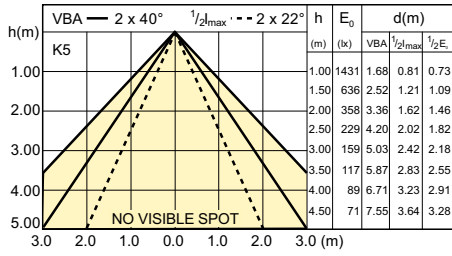

SDBE_LEDspotL_0138-Beam diagram

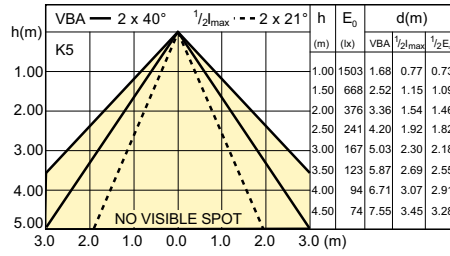

SDBE_LEDspotL_0139-Beam diagram

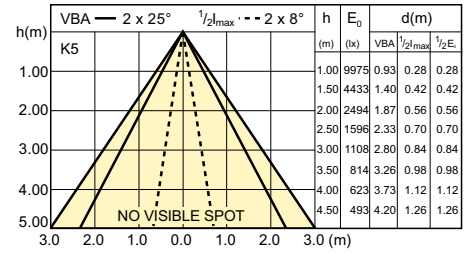

SDBE_LEDspotL_0143-Beam diagram

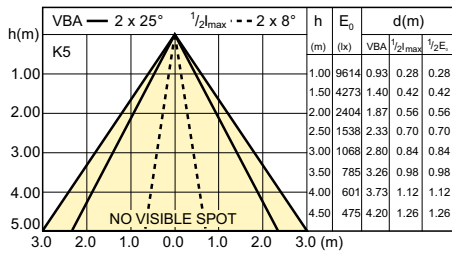

SDBE_LEDspotL_0144-Beam diagram

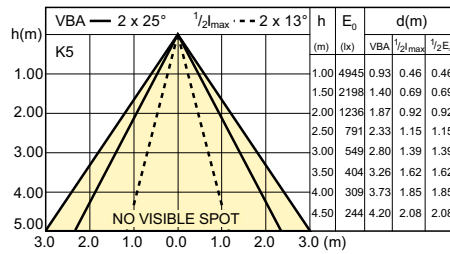

SDBE_LEDspotL_0140-Beam diagram

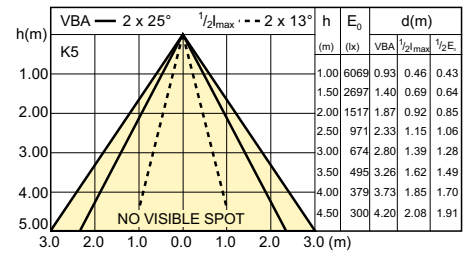

LEDspot, LEDspotLV 20-100W AR111 830 24D

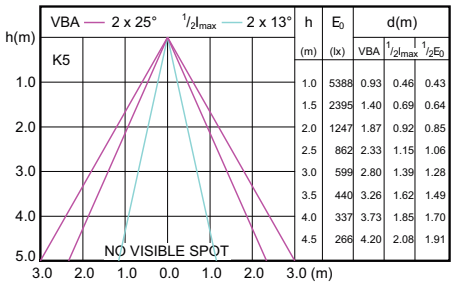

MASTER LEDspotLV 20-100W AR111 G53_4000K 1400lm 24D

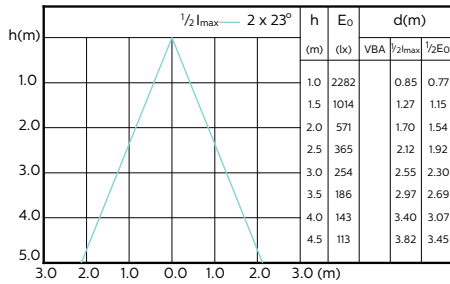

MASTER LEDspotLV AR111 100W G53 827 40D

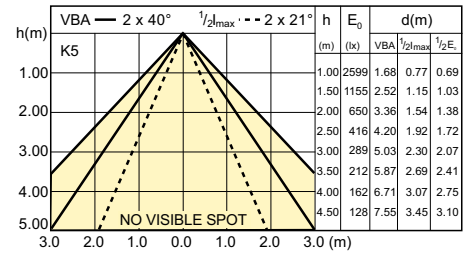

SDBE_LEDspotL_0141-Beam diagram

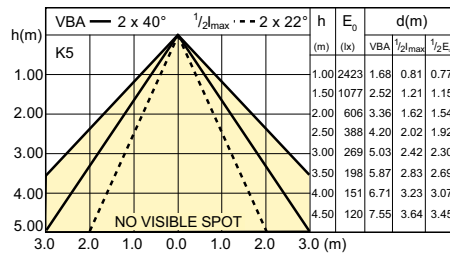

SDBE_LEDspotL_0142-Beam diagram

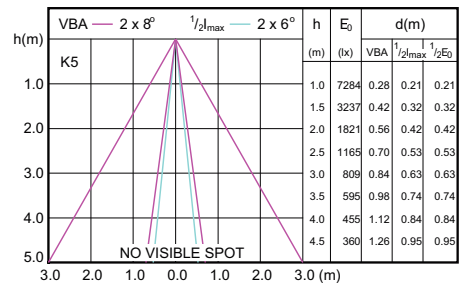

LED Lamps, MAS LEDspotLV D 11-50W AR111 G53 827 8D

MASTER LEDspot LV AR111

Beam Diagrams

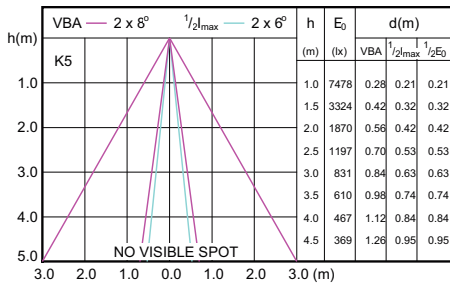

LED Lamps, MAS LEDspotLV D 11-50W AR111
G53 830 8D

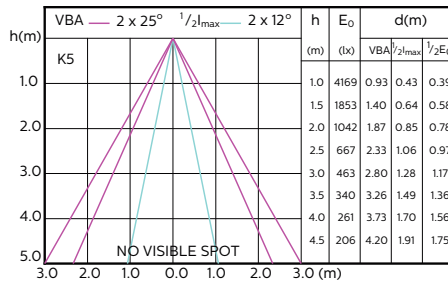

MASTER LEDspotLV AR111 75W G53 940 24D

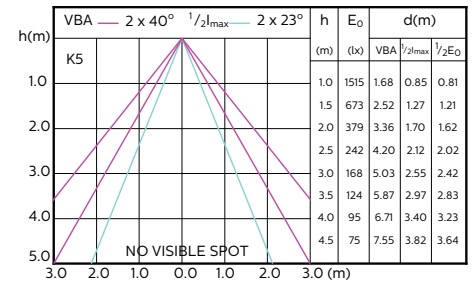

MASTER LEDspotLV AR111 75W G53 940 40D

